

CHIROPODY

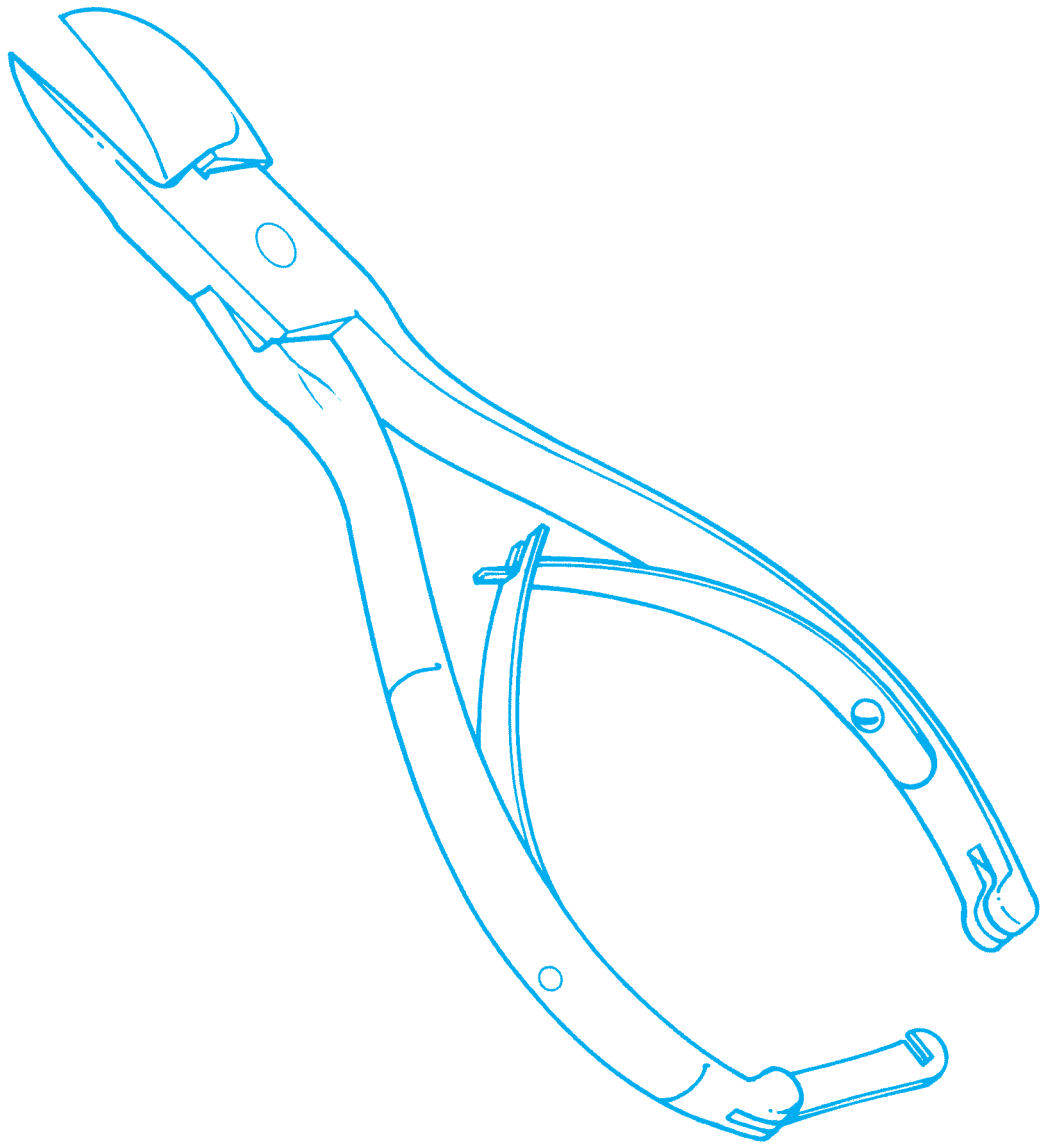

Key Products

Black's Files

Beaver Blade Holder

Nail Chisel

Nippers - Flat & Concave with & without cathch

Chiropody Scissors

CHIROPODY INSTRUMENTS



Blacks File



FM-3901 fine



FM-3902 medium



FM-3903 tungsten carbide



Probe, Swan Neck



FM-3904 flat, medium



FM-3905 flat, small



FM-3906 cupped

Beaver Blade Holder



FM-3907 hexagonal



FM-3908 round



Nail Chisel

stainless steel



FM-3909

CHIROPODY KNIVES

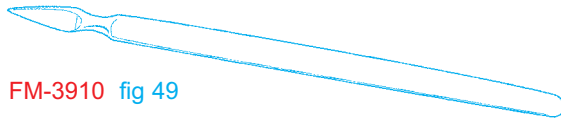

FM-3910 fig 49

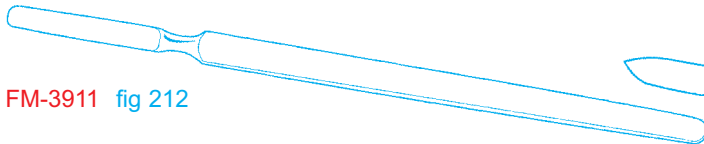

FM-3911 fig 212

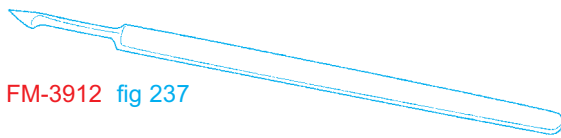

FM-3912 fig 237

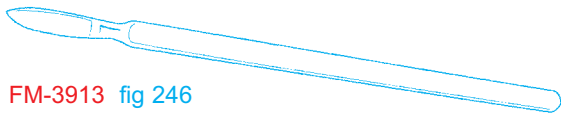

FM-3913 fig 246

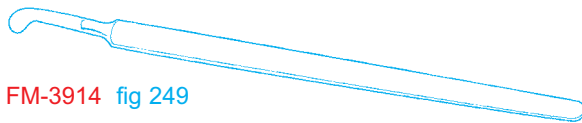

FM-3914 fig 249

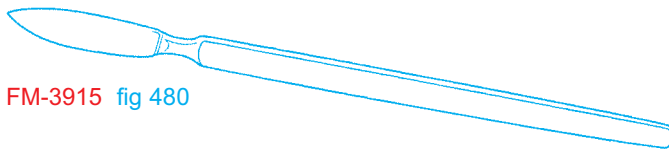

FM-3915 fig 480

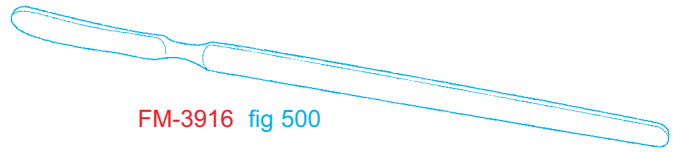

FM-3916 fig 500

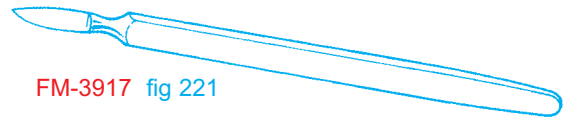

FM-3917 fig 221

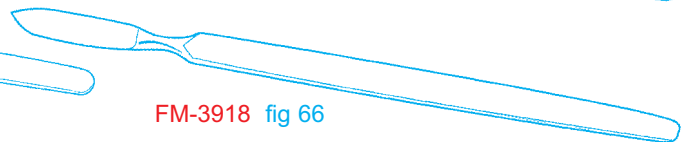

FM-3918 fig 66

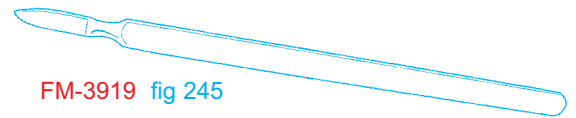

FM-3919 fig 245

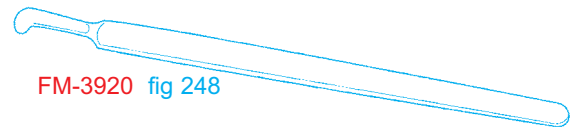

FM-3920 fig 248

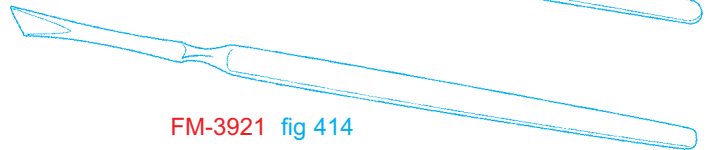

FM-3921 fig 414

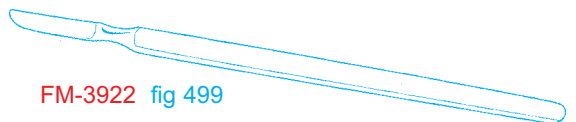

FM-3922 fig 499

NIPPERS

Concave

stainless steel with catch

FM-3923 140mm



stainless steel without catch

FM-3924 140mm

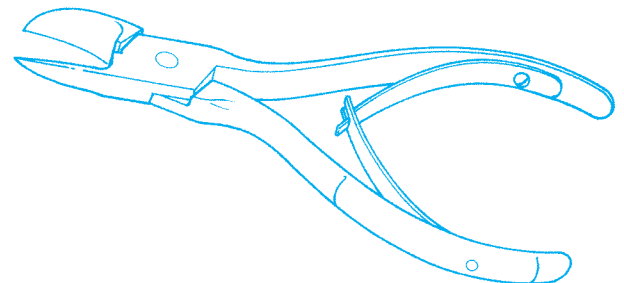

Flat

stainless steel with catch

FM-3925 140mm



stainless steel without catch

FM-3926 140mm

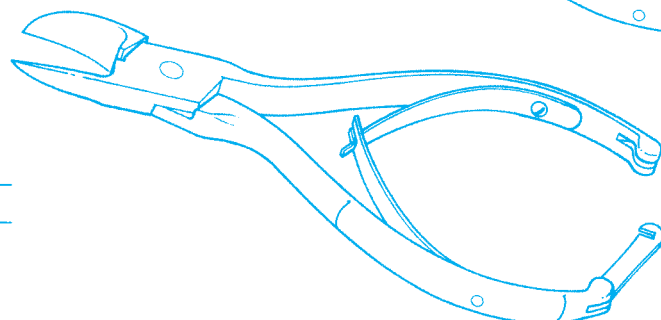

NIPPERS

Thwaites

for ingrowing nails
FM-3927 130mm

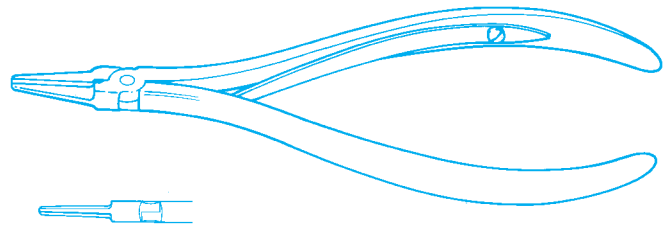

SURGICAL SCISSORS

Chiropody

short strong blades specifically designed
to cut felt with ease

straight, blunt/blunt
FM-3928 150mm

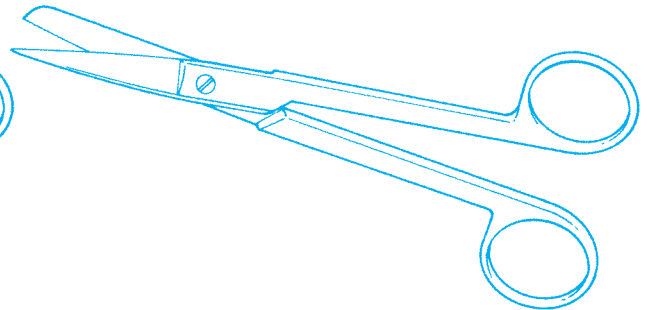
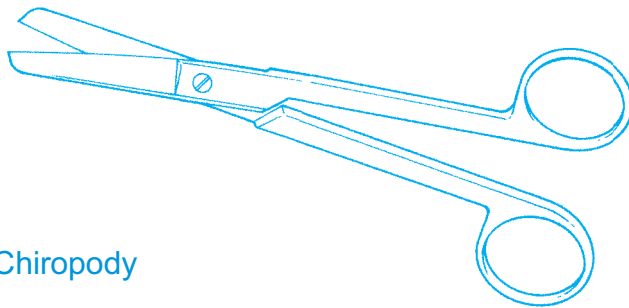

straight, blunt/sharp
FM-3929 150mm

straight, sharp/sharp
FM-3930 150mm

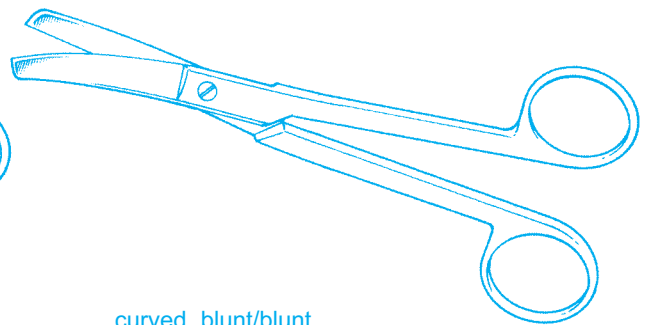
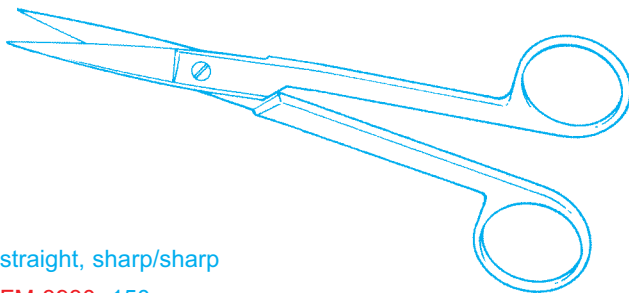

curved, blunt/blunt
FM-3931 150mm

Chiropody

curved, blunt/sharp
FM-3932 150mm

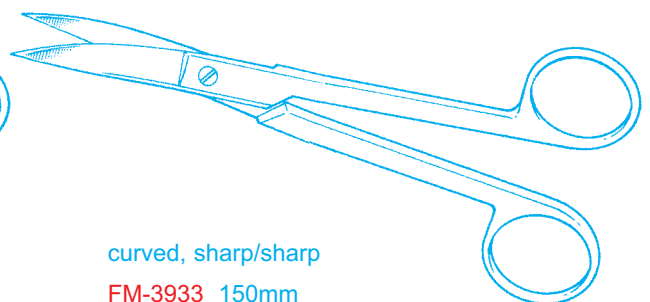
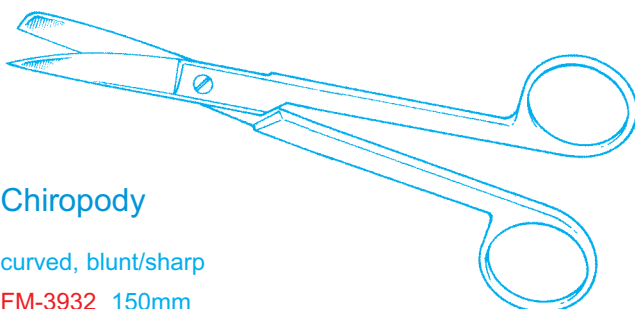

curved, sharp/sharp
FM-3933 150mm