

NEUROSURGERY

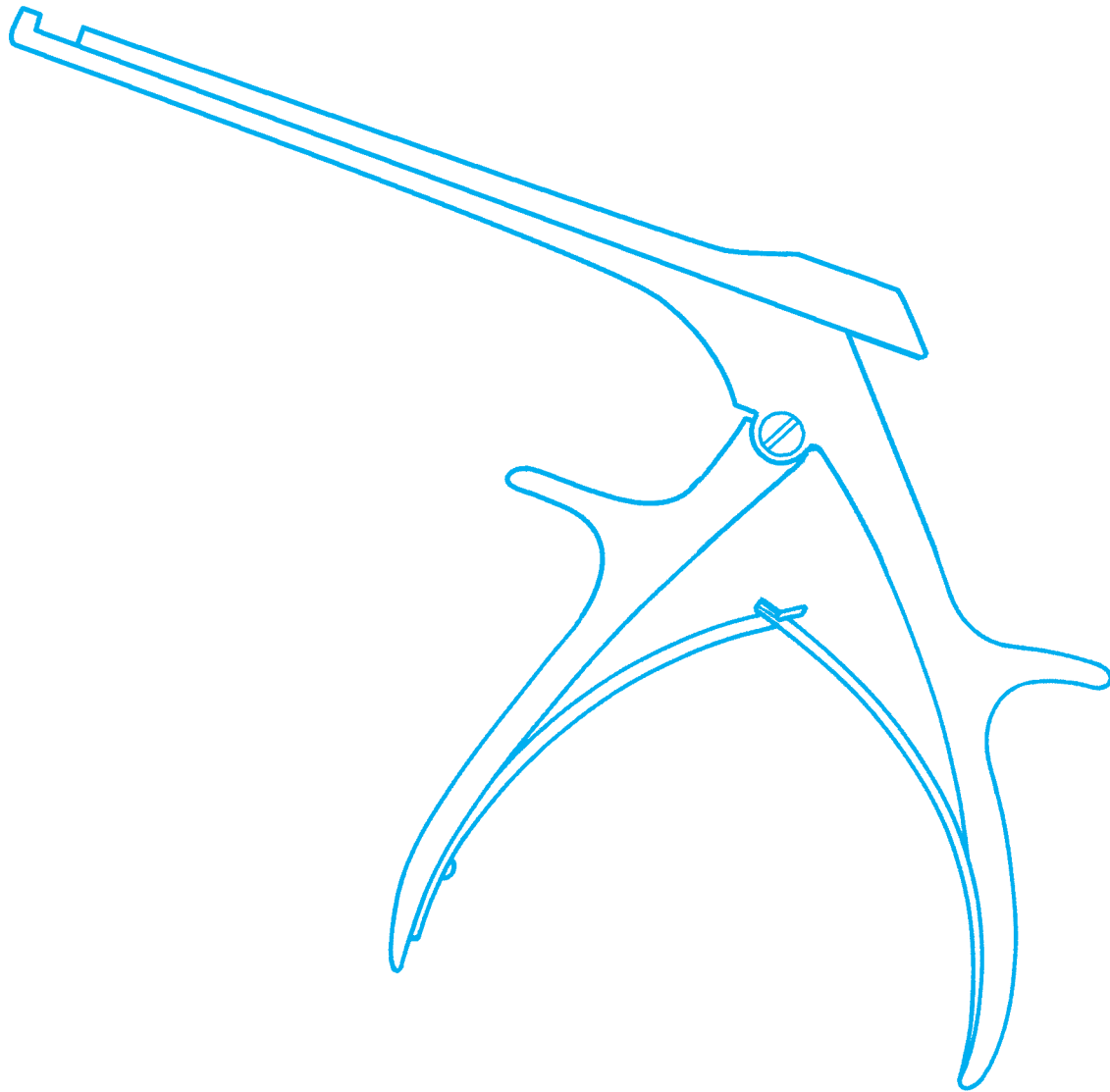

Key Products

Artery Forceps - Cairns, Crile & Cushing

Elevators & Gouges

Retractors

Rongeurs - Standard, Pituitary, Take Apart & Compound Action

Scissors & Shears

ARTERY FORCEPS

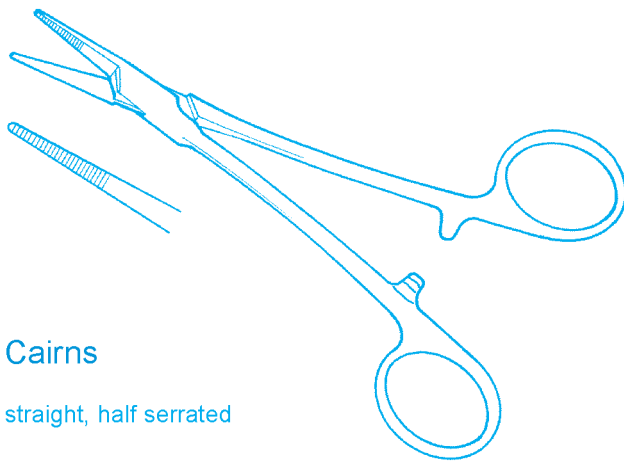

Cairns

straight, half serrated

FM-3951 145mm

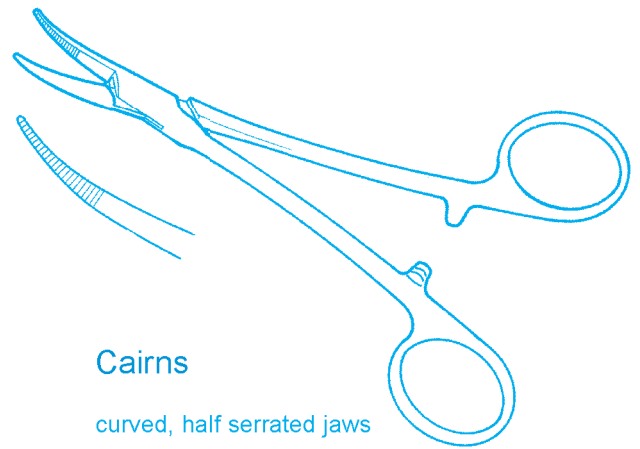

Cairns

curved, half serrated jaws

FM-3952 145mm

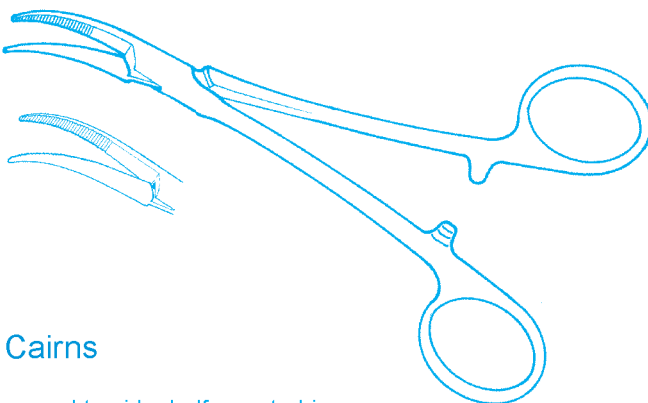

Cairns

curved to side, half serrated jaws

FM-3953 145mm

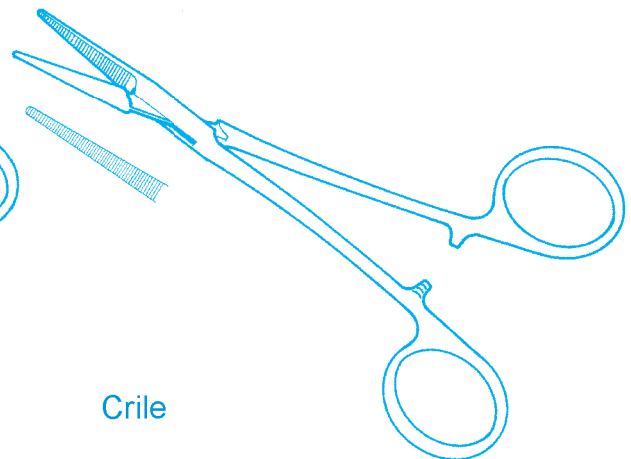

Crile

straight, serrated jaws

FM-3954 140mm

FM-3955 160mm

FM-3956 180mm

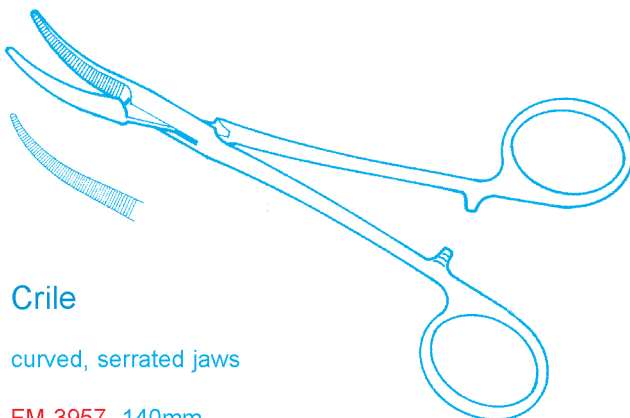

Crile

curved, serrated jaws

FM-3957 140mm

FM-3958 160mm

FM-3959 180mm

ARTERY FORCEPS

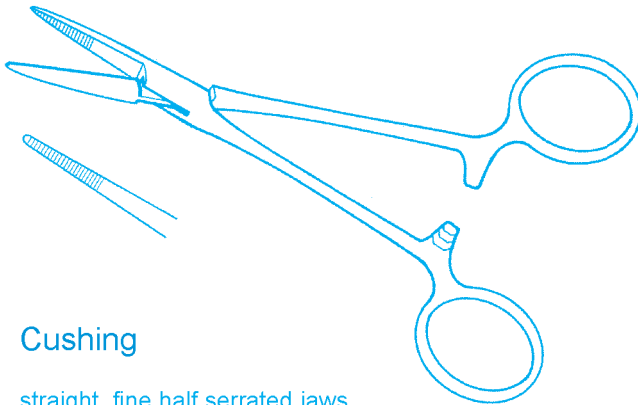

Cushing

straight, fine half serrated jaws

FM-3960 145mm

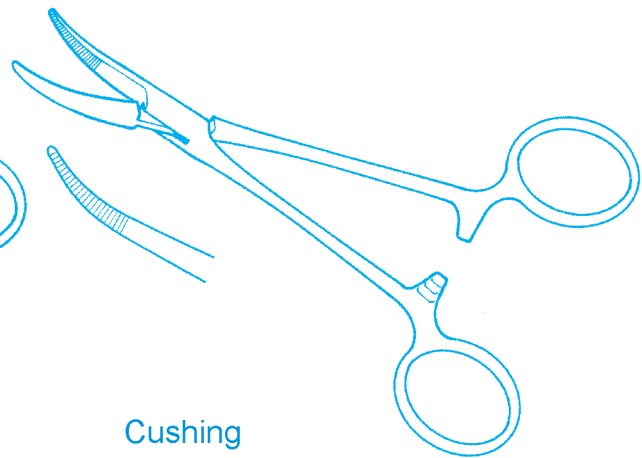

Cushing

curved, fine half serrated jaws

FM-3961 145mm

Cushing

curved to side, fine half serrated jaws

FM-3962 145mm

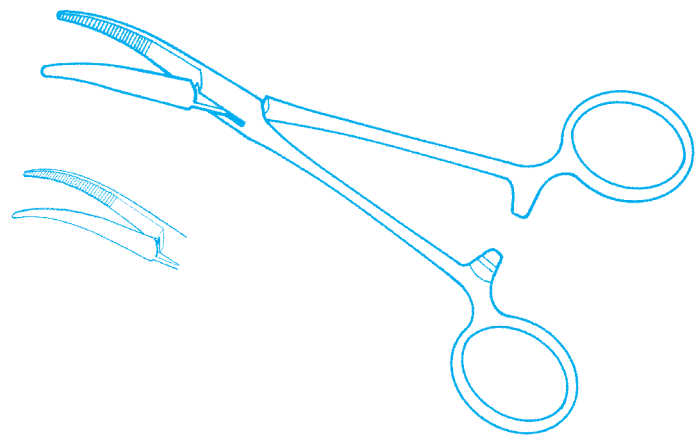

BRACE

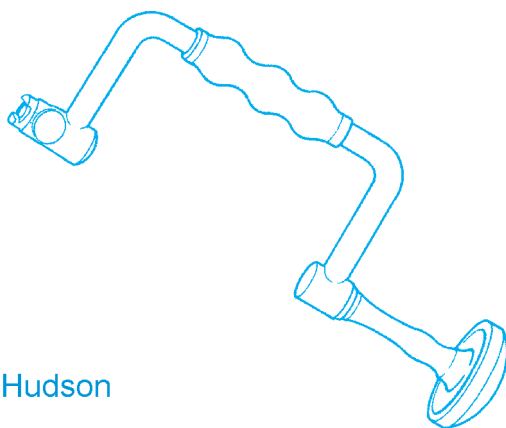

Hudson

FM-3963 universal fitting

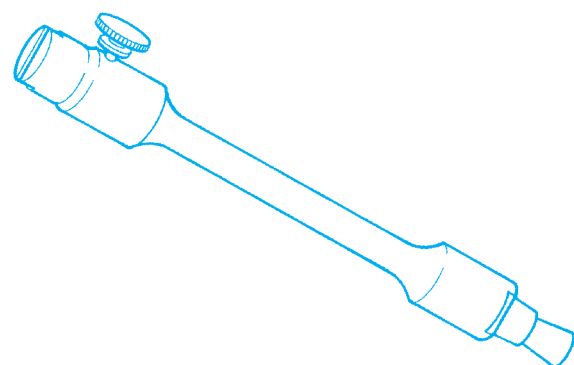

Hudson

FM-3964 for use with Hudson Brace

BURS



Hudson Conical

- FM-3965 9mm
- FM-3966 11mm
- FM-3967 13mm
- FM-3968 16mm



Hudson Spherical

- FM-3969 9mm
- FM-3970 11mm
- FM-3971 13mm
- FM-3972 16mm
- FM-3973 19mm
- FM-3974 22mm

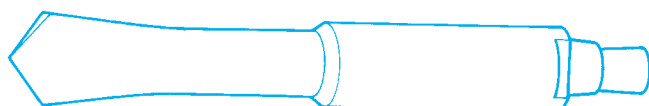

Hudson Perforator

- FM-3975 8mm
- FM-3976 10mm
- FM-3977 12mm
- FM-3978 15mm

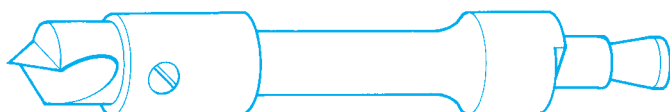

Spiral Undercut

- FM-3979 100mm x 12mm

Hudson Set

- FM-3980 Drill, Cranial, Hudson, Extension + 4 burrs (7Pcs)
- FM-3981 Hudson 7 Burrs and 1 Cerebella Extension only 1 Handle (9Pcs)

CANNULA



Cone Ventricular

graduated in cms, luer fitting, with stilette

- FM-3982 1.22mm diameter
- FM-3983 1.63mm diameter
- FM-3984 2.03mm diameter



Jefferson Ventricular

graduated in cms, luer fitting, with stilette

- FM-3985 60mm
- FM-3986 80mm
- FM-3987 100mm

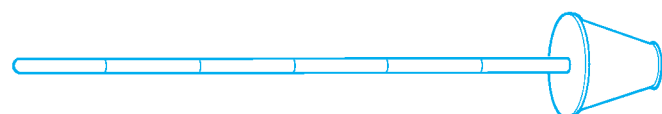

CLIP FORCEPS

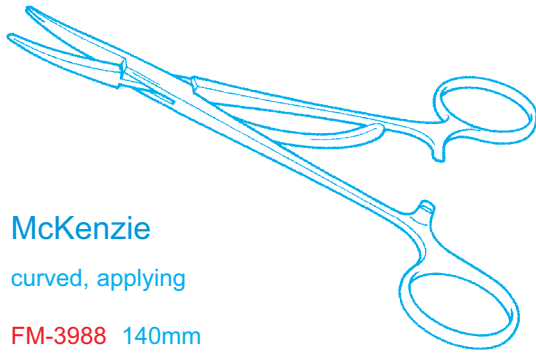

McKenzie

curved, applying

FM-3988 140mm

FM-3989 175mm

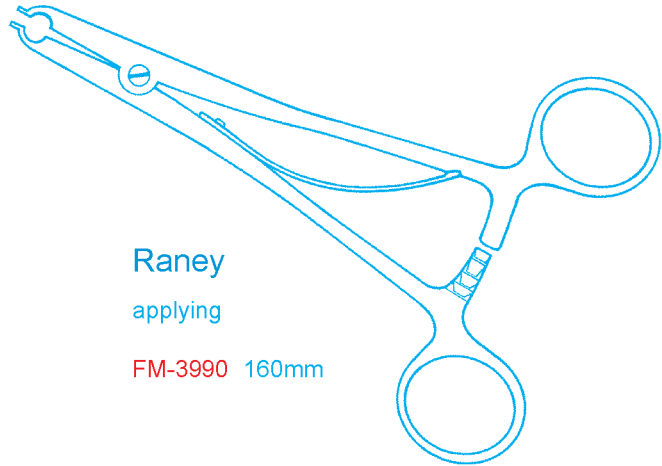

Raney

applying

FM-3990 160mm

CURETTES

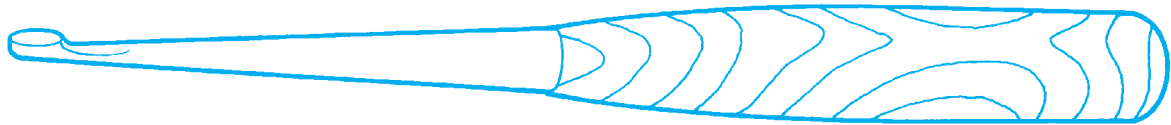

American Spinal

straight, tufnol handle, 250mm

FM-3991 2.0mm x 4mm

FM-3992 2.5mm x 4.5mm

FM-3993 2.75mm x 5mm

FM-3994 3.0mm x 5.5mm

FM-3995 3.25mm x 6mm

FM-3996 4.0mm x 7mm

FM-3997 6.0mm x 9.5mm

FM-3998 7.0mm x 14mm

FM-3999 9.0mm x 17mm

angled, tufnol handle, 250mm

FM-4000 2.0mm x 4mm

FM-4001 2.5mm x 4.5mm

FM-4002 2.75mm x 5mm

FM-4003 3.0mm x 5.5mm

FM-4004 3.25mm x 6mm

FM-4005 4.0mm x 7mm

FM-4006 6.0mm x 9.5mm

FM-4007 7.0mm x 14mm

FM-4008 9.0mm x 17mm

DISSECTING FORCEPS

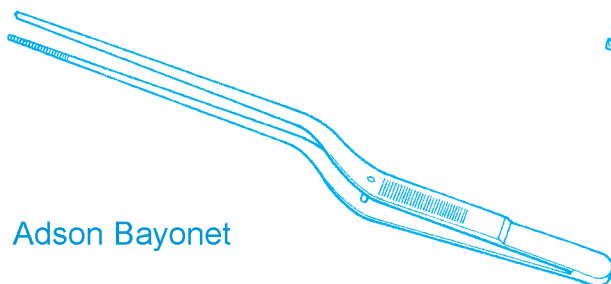

Adson Bayonet

serrated, fine

FM-4009 190mm

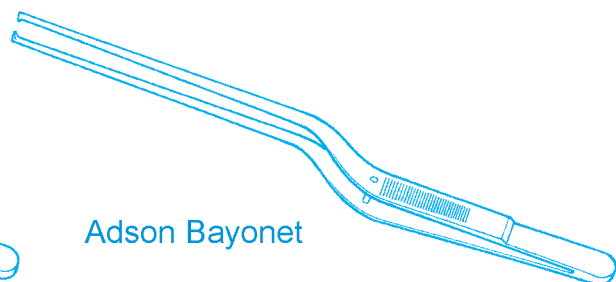

Adson Bayonet

1/2 teeth

FM-4010 190mm

DISSECTING FORCEPS



Cairns

delicate, 2/3 teeth

FM-4011 165mm

FM-4012 215mm



Dott (Cairns)

fine, 1/2 teeth

FM-4013 175mm



Jefferson

fine, 1/2 teeth

FM-4014 175mm



Pennybacker

3/4 teeth

FM-4015 165mm

DISSECTORS



Pennybacker

double ended

FM-4016 225mm



Swedish

double ended, light model

FM-4017 175mm

DRESSING FORCEPS

Cairns (Dott)

fine serrated jaws
FM-4018 180mm



Cairns

medium serrated jaws
FM-4019 215mm



Jefferson

serrated jaws
FM-4020 180mm

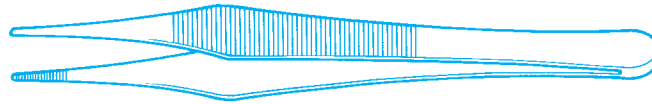

DURAL HOOKS

Adson

blunt
FM-4021 190mm



Adson

fine, sharp
FM-4022 190mm



Cairns

fine, sharp
FM-4023 125mm



Cairns

sharp
FM-4024 125mm



ELEVATORS

Adson Periosteal

straight



FM-4025 165mm x 5mm wide

FM-4026 165mm x 7mm wide

Adson Periosteal

curved



FM-4027 165mm x 5mm wide

FM-4028 165mm x 7mm wide

Cobb



FM-4029 275mm x 10mm

FM-4030 275mm x 13mm

FM-4031 275mm x 19mm

FM-4032 275mm x 24mm

FM-4033 350mm x 19mm

FM-4034 350mm x 24mm

Pennybacker

curved, sharp



FM-4035 160mm x 6mm wide

GOUGES

Capener

cranked, tufnol handle, length 235mm



FM-4036 6mm

FM-4037 8mm

FM-4038 11mm

FM-4039 16mm

RETRACTORS

Cairns Strip

malleable, copper

- FM-4040 200mm x 6mm
- FM-4041 200mm x 8mm
- FM-4042 200mm x 10mm
- FM-4043 200mm x 11mm
- FM-4044 200mm x 13mm
- FM-4045 200mm x 16mm
- FM-4046 200mm x 19mm
- FM-4047 200mm x 25mm

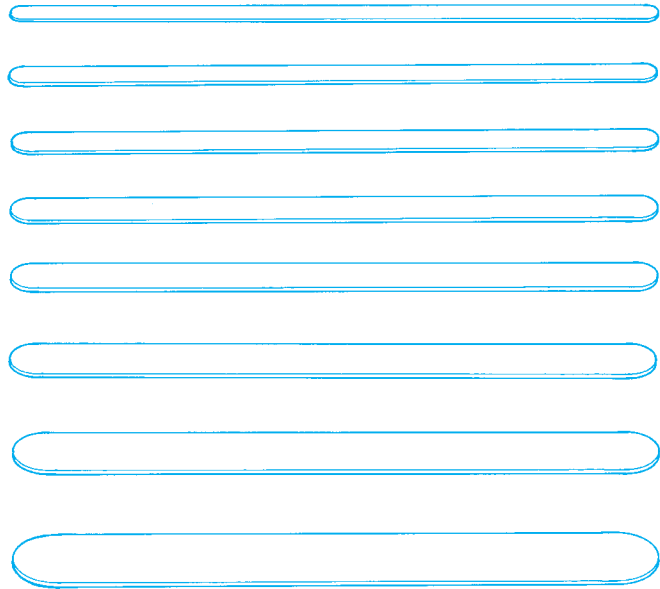

Charnley Laminectomy

set of 2, one with central hook and one with 2 blunt hooks together with spain weight (1.47kg) and chain

- FM-4048 65mm x 175mm

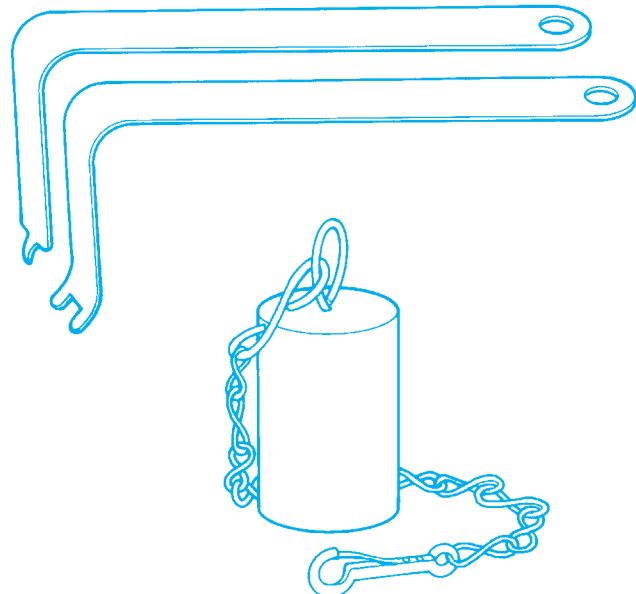

RETRACTORS



Cushing

FM-4049 190mm

FM-4050 280mm



Dandy

straight

FM-4051 200mm

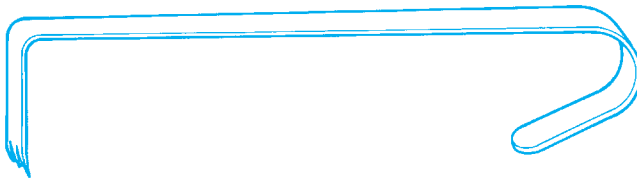

Hibbs

200mm

FM-4052 10mm x 38mm blades

FM-4053 16mm x 54mm blades

FM-4054 25mm x 70mm blades



Love

nerve root

FM-4055 straight

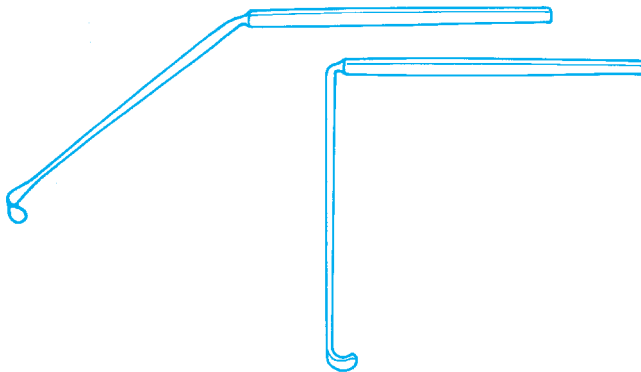

FM-4056 angled

FM-4057 right angled



O'Connell

double ended

FM-4058 215mm

RETRACTORS SELF RETAINING

Cone

blunt, 3/4 prong

FM-4059 125mm

FM-4060 160mm

FM-4061 200mm

FM-4062 260mm

sharp, 3/4 prong

FM-4063 125mm

FM-4064 160mm

FM-4065 200mm

FM-4066 260mm

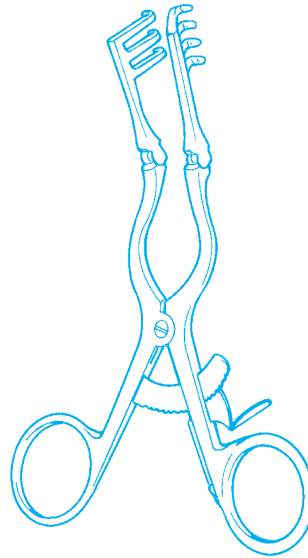

Harvey-Jackson

hinged arms, 305mm

FM-4067 38mm x 44mm blades

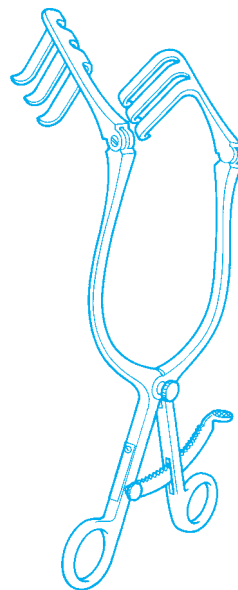

**RETRACTORS
SELF RETAINING**

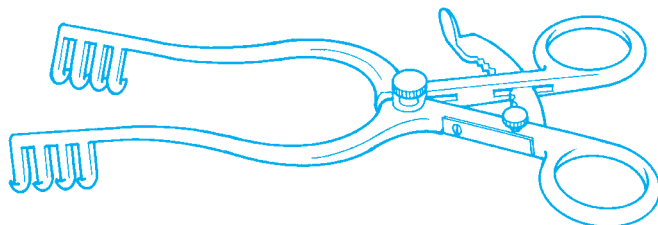

Henderson

blunt

FM-4068 135mm

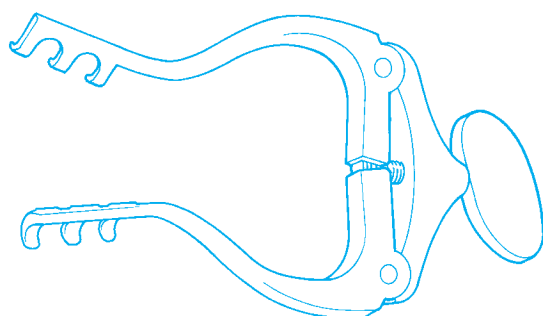

Jansen

blunt

FM-4069 112mm

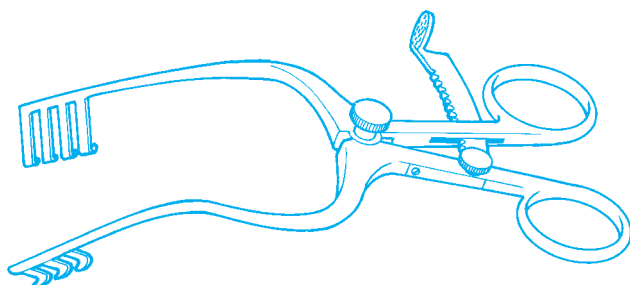

Jefferson

curved, blunt, 3/4 prong

FM-4070 140mm

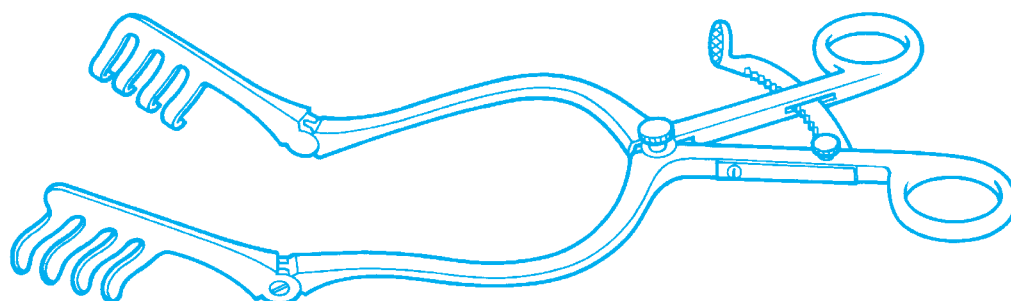

Mayo-Adson Laminectomy

hinged arms

FM-4071 290mm

RONGEURS

Beck

130mm effective length

FM-4072 2mm bite

Cushing

straight

FM-4073 4mm bite x 130mm

FM-4074 5mm bite x 130mm

FM-4075 7mm bite x 130mm

FM-4076 1mm bite x 180mm

FM-4077 2mm bite x 180mm

FM-4078 3mm bite x 180mm

FM-4079 4mm bite x 180mm

FM-4080 5mm bite x 180mm

FM-4081 1mm bite x 200mm

FM-4082 2mm bite x 200mm

FM-4083 3mm bite x 200mm

FM-4084 4mm bite x 200mm

FM-4085 5mm bite x 200mm

FM-4086 1mm bite x 220mm

FM-4087 2mm bite x 220mm

FM-4088 3mm bite x 220mm

FM-4089 4mm bite x 220mm

FM-4090 5mm bite x 220mm

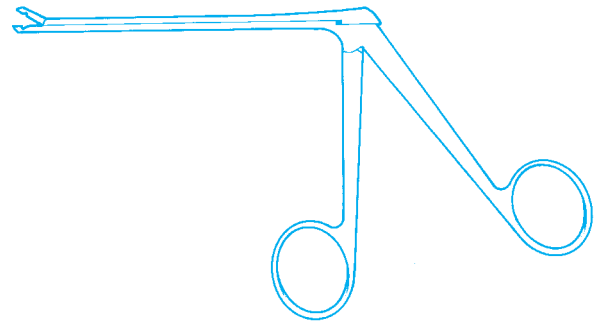

bayonet, straight

FM-4091 1mm bite x 220mm

FM-4092 2mm bite x 220mm

FM-4093 3mm bite x 220mm

FM-4094 4mm bite x 220mm

FM-4095 5mm bite x 220mm

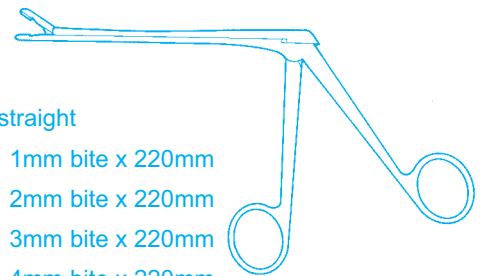

Cushing

upward

FM-4096 3mm bite x 130mm

FM-4097 4mm bite x 130mm

FM-4098 5mm bite x 130mm

FM-4099 1mm bite x 180mm

FM-4100 2mm bite x 180mm

FM-4101 3mm bite x 180mm

FM-4102 4mm bite x 180mm

FM-4103 5mm bite x 180mm

FM-4104 1mm bite x 200mm

FM-4105 2mm bite x 200mm

FM-4106 3mm bite x 200mm

FM-4107 4mm bite x 200mm

FM-4108 5mm bite x 200mm

FM-4109 1mm bite x 220mm

FM-4110 2mm bite x 220mm

FM-4111 3mm bite x 220mm

FM-4112 4mm bite x 220mm

FM-4113 5mm bite x 220mm

bayonet, upward

FM-4114 1mm bite x 220mm

FM-4115 2mm bite x 220mm

FM-4116 3mm bite x 220mm

FM-4117 4mm bite x 220mm

FM-4118 5mm bite x 220mm

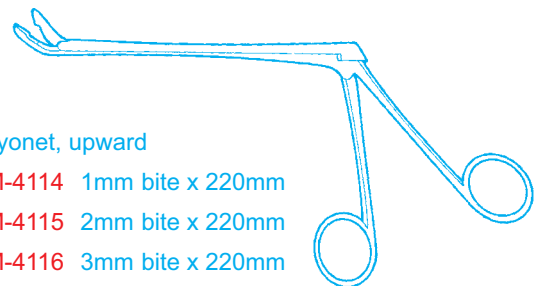

Cushing

downward

FM-4119 3mm bite x 130mm

FM-4120 4mm bite x 130mm

FM-4121 5mm bite x 130mm

FM-4122 1mm bite x 180mm

FM-4123 2mm bite x 180mm

FM-4124 3mm bite x 180mm

FM-4125 4mm bite x 180mm

FM-4126 5mm bite x 180mm

FM-4127 1mm bite x 200mm

FM-4128 2mm bite x 200mm

FM-4129 3mm bite x 200mm

FM-4130 4mm bite x 200mm

FM-4131 5mm bite x 200mm

FM-4132 1mm bite x 220mm

FM-4133 2mm bite x 220mm

FM-4134 3mm bite x 220mm

FM-4135 4mm bite x 220mm

FM-4136 5mm bite x 220mm

bayonet, downward

FM-4137 1mm bite x 220mm

FM-4138 2mm bite x 220mm

FM-4139 3mm bite x 220mm

FM-4140 4mm bite x 220mm

FM-4141 5mm bite x 220mm

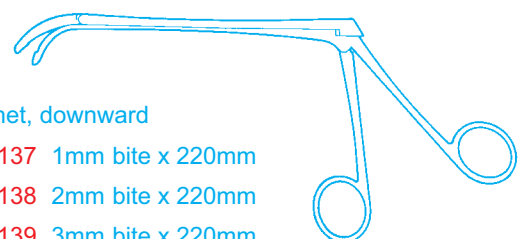

RONGEURS

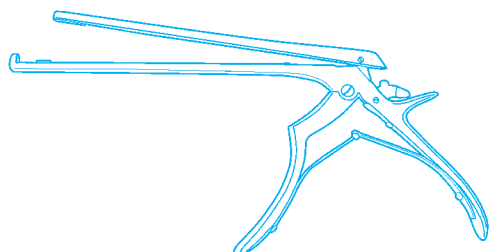

upward cutting,

- FM-4148 1mm bite x 200mm
- FM-4149 2mm bite x 200mm
- FM-4150 3mm bite x 200mm
- FM-4151 4mm bite x 200mm
- FM-4152 5mm bite x 200mm
- FM-4153 6mm bite x 200mm

Ferris-Smith-Kerrison

one piece hinge system allows ease of disassembly cleaning and reassembly upward cutting,

- FM-4142 1mm bite x 180mm
- FM-4143 2mm bite x 180mm
- FM-4144 3mm bite x 180mm
- FM-4145 4mm bite x 180mm
- FM-4146 5mm bite x 180mm
- FM-4147 6mm bite x 180mm

40° upward cutting,

- FM-4166 1mm bite x 220mm
- FM-4167 2mm bite x 220mm
- FM-4168 3mm bite x 220mm
- FM-4169 4mm bite x 220mm
- FM-4170 5mm bite x 220mm
- FM-4171 6mm bite x 220mm

40° upward cutting,

- FM-4160 1mm bite x 200mm
- FM-4161 2mm bite x 200mm
- FM-4162 3mm bite x 200mm
- FM-4163 4mm bite x 200mm
- FM-4164 5mm bite x 200mm
- FM-4165 6mm bite x 200mm

40° upward cutting,

- FM-4154 1mm bite x 180mm
- FM-4155 2mm bite x 180mm
- FM-4156 3mm bite x 180mm
- FM-4157 4mm bite x 180mm
- FM-4158 5mm bite x 180mm
- FM-4159 6mm bite x 180mm

40° upward cutting, bayonet

- FM-4184 1mm bite x 280mm
- FM-4185 2mm bite x 280mm
- FM-4186 3mm bite x 280mm
- FM-4187 4mm bite x 280mm
- FM-4188 5mm bite x 280mm
- FM-4189 6mm bite x 280mm

40° upward cutting, bayonet

- FM-4178 1mm bite x 240mm
- FM-4179 2mm bite x 240mm
- FM-4180 3mm bite x 240mm
- FM-4181 4mm bite x 240mm
- FM-4182 5mm bite x 240mm
- FM-4183 6mm bite x 240mm

40° upward cutting, curved

- FM-4172 1mm bite x 200mm
- FM-4173 2mm bite x 200mm
- FM-4174 3mm bite x 200mm
- FM-4175 4mm bite x 200mm
- FM-4176 5mm bite x 200mm
- FM-4177 6mm bite x 200mm

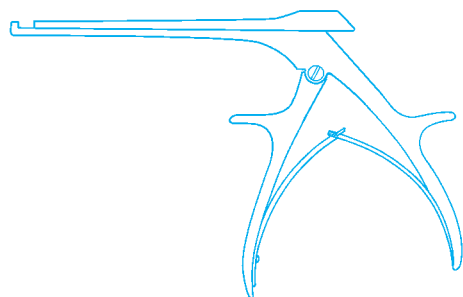

40° upward cutting,

- FM-4195 1mm bite x 200mm
- FM-4196 2mm bite x 200mm
- FM-4197 3mm bite x 200mm
- FM-4198 4mm bite x 200mm
- FM-4199 5mm bite x 200mm

Kerrison

40° upward cutting,

- FM-4190 1mm bite x 180mm
- FM-4191 2mm bite x 180mm
- FM-4192 3mm bite x 180mm
- FM-4193 4mm bite x 180mm
- FM-4194 5mm bite x 180mm

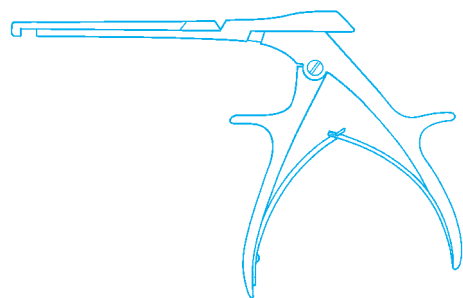

40° downward cutting,

- FM-4205 1mm bite x 200mm
- FM-4206 2mm bite x 200mm
- FM-4207 3mm bite x 200mm
- FM-4208 4mm bite x 200mm
- FM-4209 5mm bite x 200mm

Kerrison

40° downward cutting,

- FM-4200 1mm bite x 180mm
- FM-4201 2mm bite x 180mm
- FM-4202 3mm bite x 180mm
- FM-4203 4mm bite x 180mm
- FM-4204 5mm bite x 180mm

RONGEURS

Love-Grunwald

straight,

FM-4210 2mm bite x 180mm

FM-4211 3mm bite x 180mm

FM-4212 4mm bite x 180mm

upward,

FM-4213 2mm bite x 180mm

FM-4214 3mm bite x 180mm

FM-4215 4mm bite x 180mm

downward,

FM-4216 2mm bite x 180mm

FM-4217 3mm bite x 180mm

FM-4218 4mm bite x 180mm

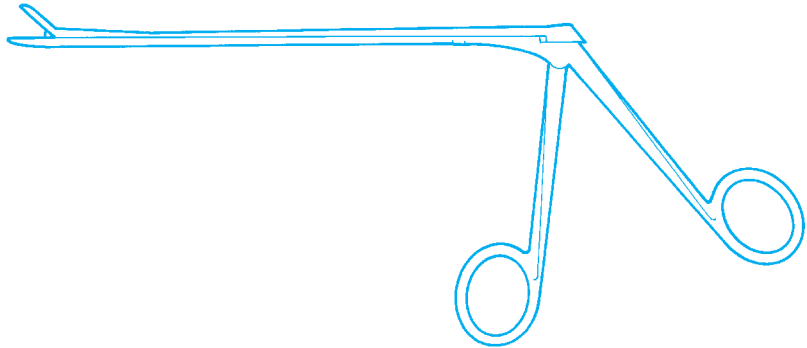

Northfield

upward,

FM-4219 4mm bite x 130mm

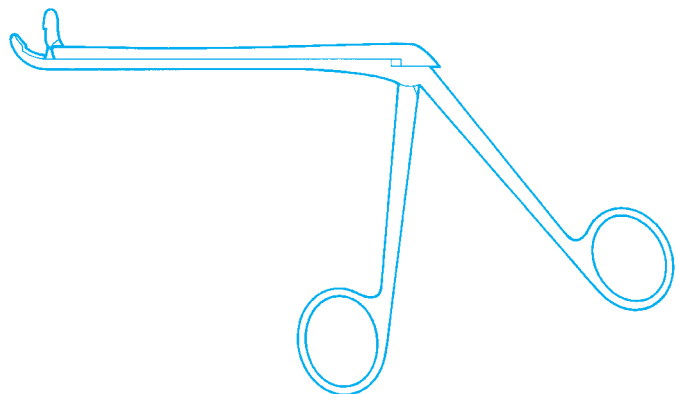

Pennybacker

straight,

FM-4220 3mm bite x 115mm

FM-4221 4mm bite x 120mm

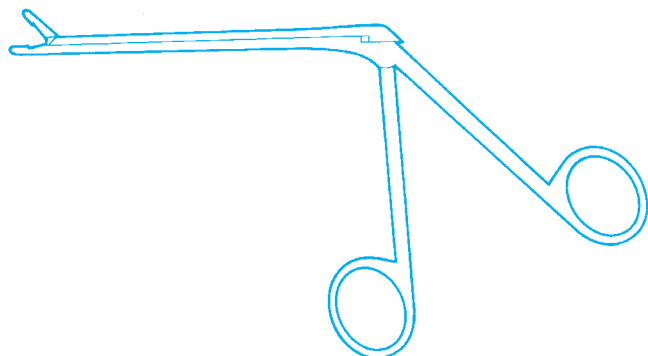

RONGEURS

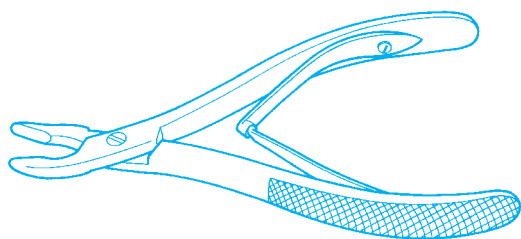

Glasgow

curved on flat, screw joint, 145mm
FM-4222 4mm bite

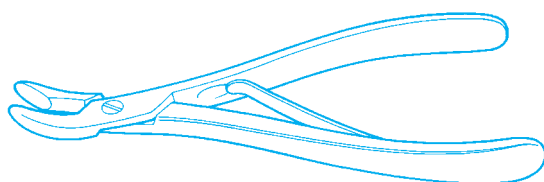

Jansen

small curve, screw joint, 150mm
FM-4223 8mm bite

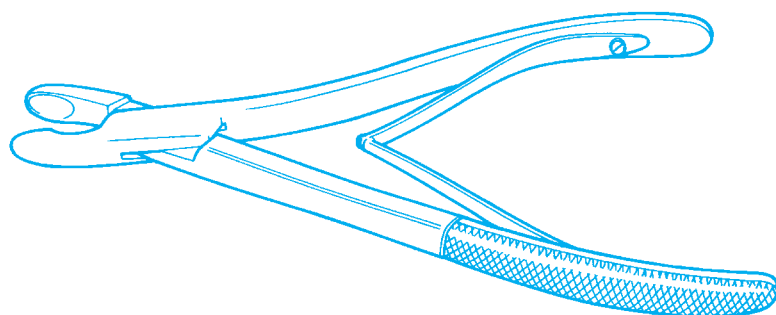

Northfield

straight, 200mm
FM-4224 10mm bite

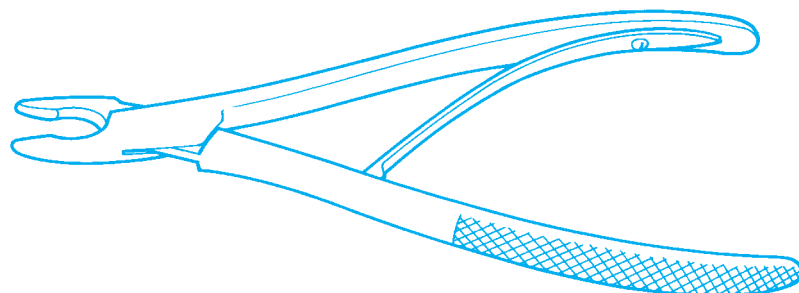

Pennybacker

straight, fine jaw, 200mm
FM-4225 4mm bite

RONGEURS

Ruskin

compound action, 185mm

FM-4226 straight, 6mm bite

FM-4227 curved, 6mm bite

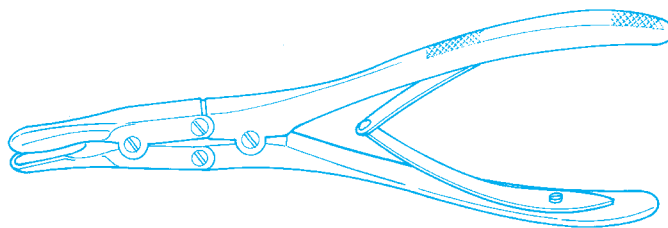

Trotter

angled to side, screw joint, 200mm

FM-4228 10mm bite

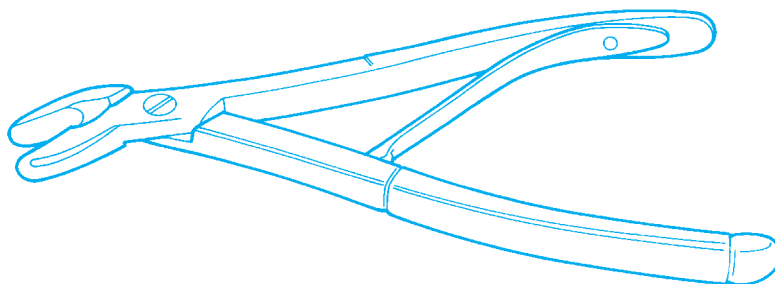

Van Havre (Sargent)

compound action, 225mm

FM-4229 straight, 10mm bite

FM-4230 curved, 10mm bite

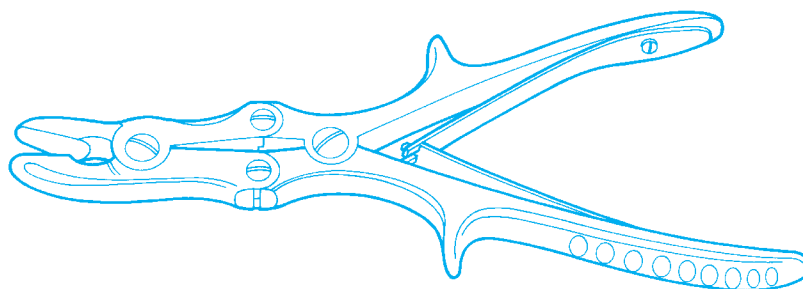

SAWS

De Martel Gigli Guide

FM-4231 305mm



Gigli

FM-4232 305mm

FM-4233 500mm

FM-4234 305mm, set of 5 pcs

FM-4235 500mm, set of 5 pcs

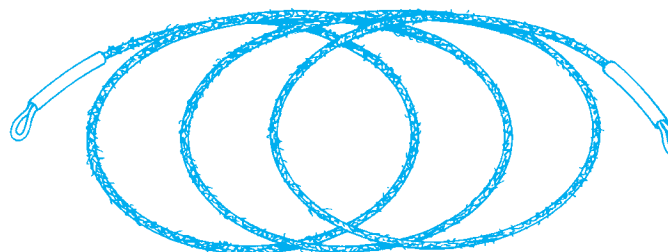

Gigli Handle

pair

FM-4236 50mm

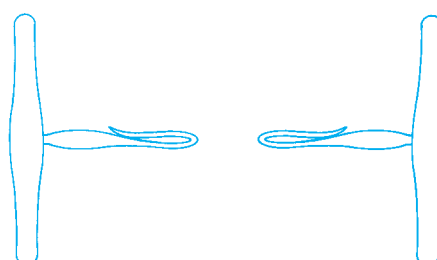

SCISSORS

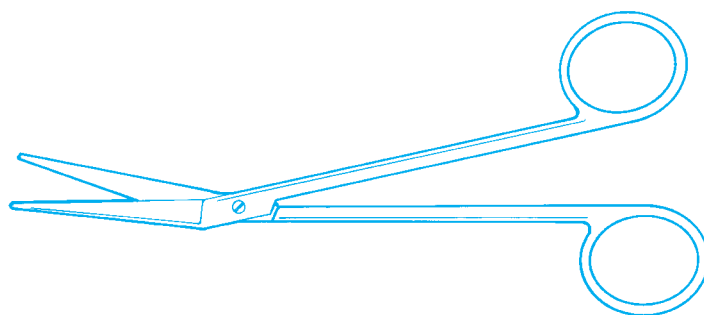

Cairns

angled on flat
FM-4237 175mm



McKissock

dural, straight
FM-4238 145mm



McKissock

dural, curved
FM-4239 145mm

SHEARS

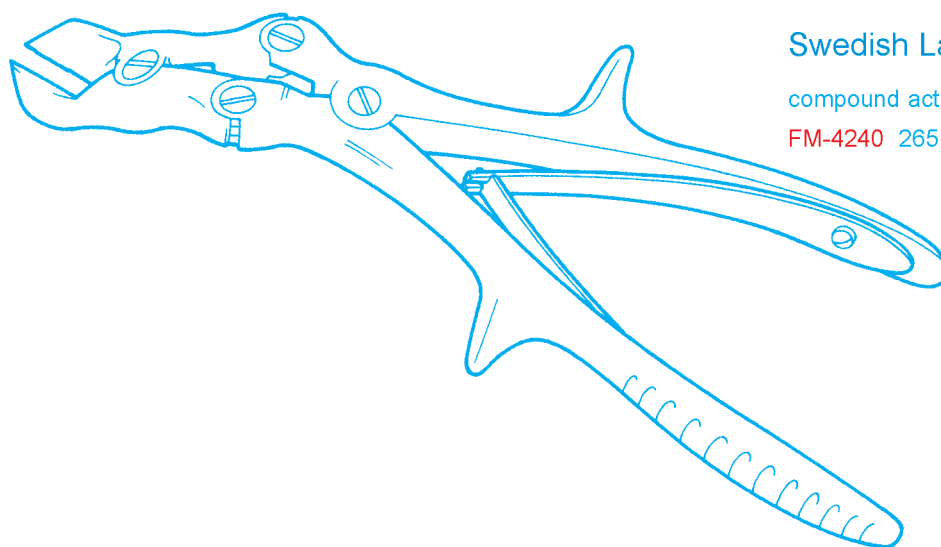

Swedish Laminectomy

compound action
FM-4240 265mm

SUCTION TUBES

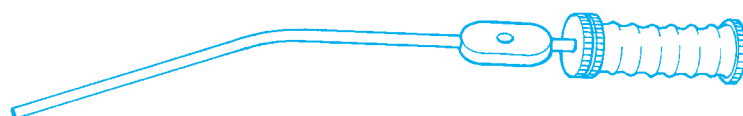

Adson Frazier

angled, 175mm
FM-4241 7fg, 2.3mm
FM-4242 8fg, 2.7mm
FM-4243 9fg, 3.0mm