

PROCTOLOGY

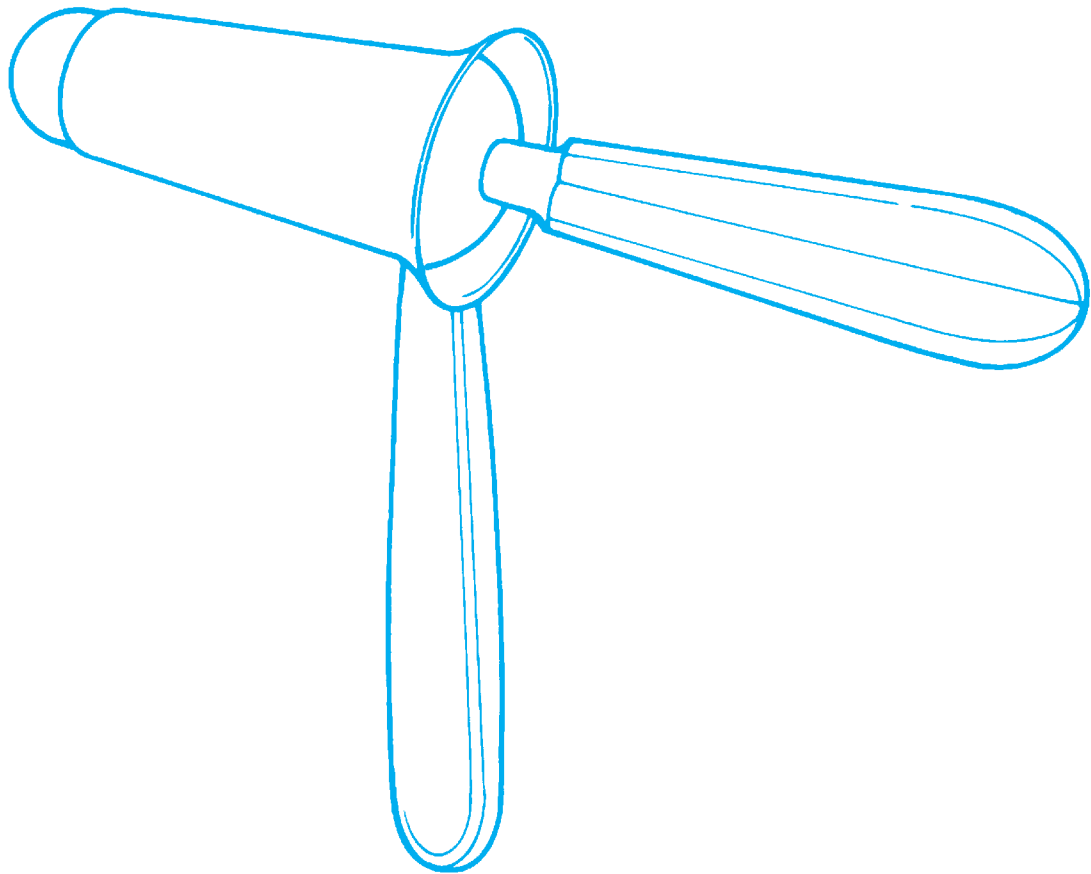

Key Products

Biopsy Forceps

Rectal Excision Clamps Rectal Dilators

Mummary Fistula Directors

Haemorrhoid Ligators & Forceps

Proctoscopes, Specula & Sigmoidosopes

Scissors - Rectal & Colonic

BIOPSY FORCEPS



Yeoman

basket-jawed to use through sigmoidoscope

fig. 2

FM-3401 250mm effective length

FM-3402 355mm effective length

FM-3403 430mm effective length

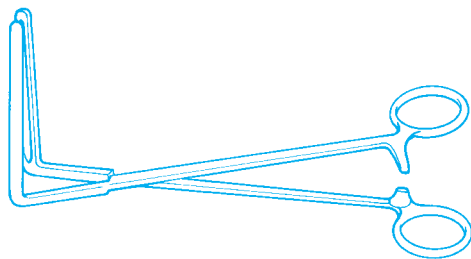

fig. 3

FM-3404 250mm effective length

FM-3405 355mm effective length

FM-3406 430mm effective length



Finch Rectal Excision

with hollowed jaws

FM-3407 215mm, 75mm blade

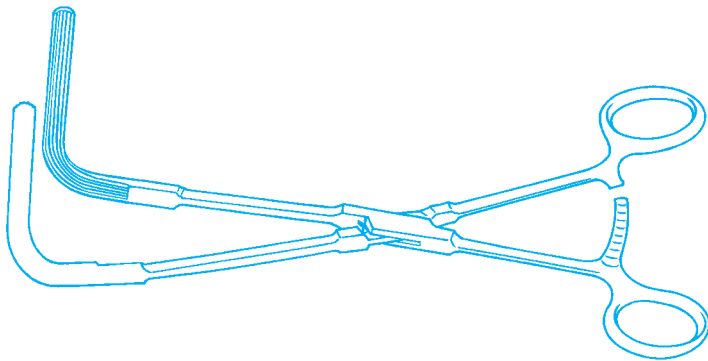

Lloyd-Davies Rectal Excision

longitudinal serrations

FM-3408 305mm, 70mm blade

CLAMPS

CLAMPS ATRAUMATIC

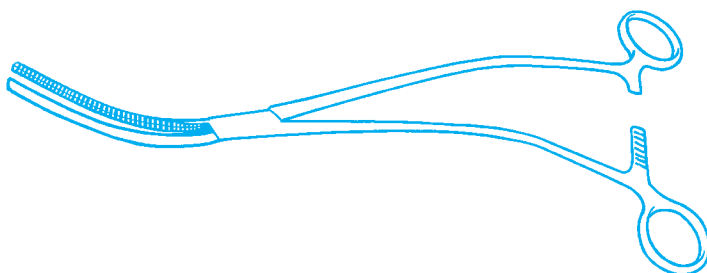

Einsell Foss Colon Resection

curved

FM-3409 305mm

CLAMPS ATRAUMATIC

Hayes Colon Resection

jaws angled 70°

FM-3410 260mm, 80mm jaws

FM-3411 280mm, 100mm jaws

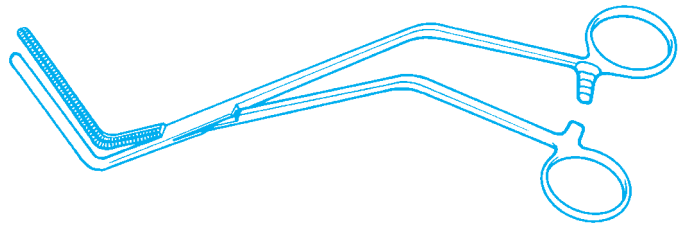

DILATORS

St Marks Rectal

plastic

FM-3412 small

FM-3413 large

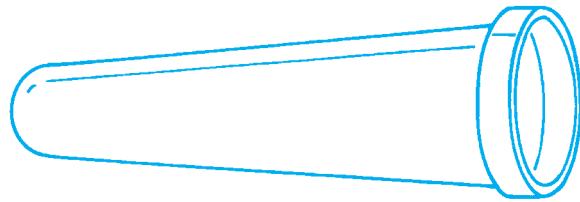

DIRECTORS

Lockhart Mummery Fistula

length 165mm

FM-3414 No.1 straight



FM-3415 No.2 45° curve



FM-3416 No.3 90° curve



FM-3417 No.4 Retrograde



DISSECTING FORCEPS

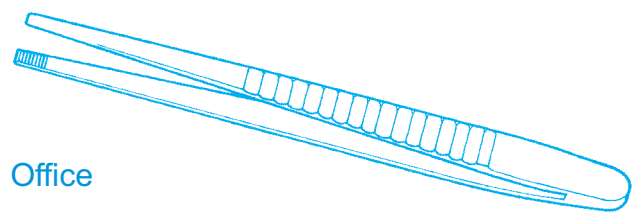

Office
serrated
FM-3418 150mm
FM-3419 200mm
FM-3420 250mm

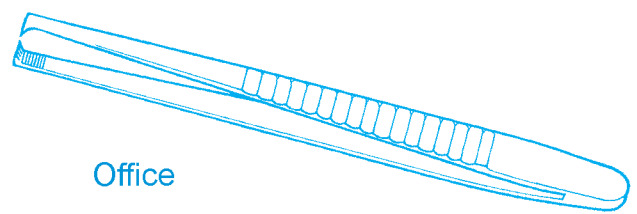

Office
2/3 teeth 
FM-3421 150mm
FM-3422 200mm
4/5 teeth 
FM-3423 150mm
FM-3424 200mm
FM-3425 250mm

HAEMORRHOID LIGATOR SET

Barron

comprising ligator, conical loader,
300 'O' rings and handle
FM-3426 215mm, complete
FM-3427 spare conical loader
FM-3428 spare rings, pack of 300
FM-3429 spare handle
FM-3430 spare stem

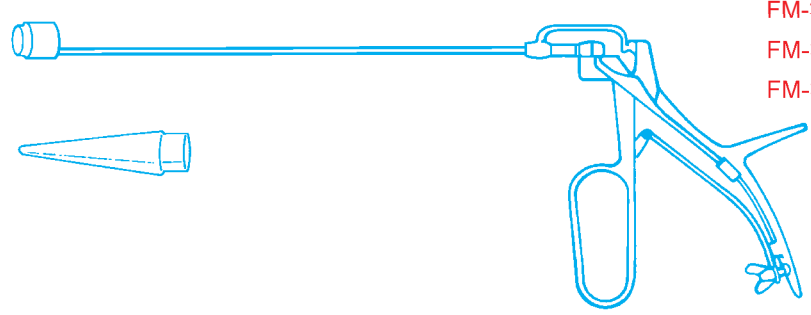

McGivney

comprising ligator, conical loader,
300 'O' rings and handle
FM-3431 complete
FM-3432 spare conical loader
FM-3433 spare ligator

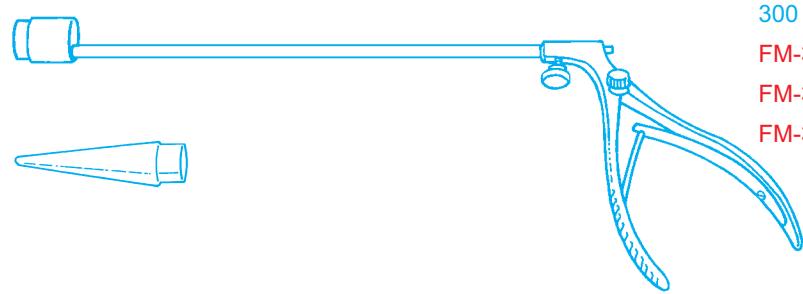

HAEMORRHOID SEIZING FORCEPS

St George's Pattern

3/4 teeth

FM-3434 190mm

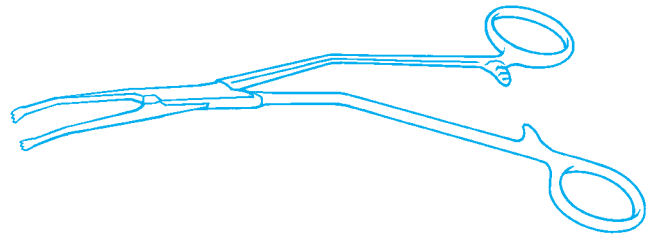

PROCTOSCOPES

Kelly

with obturator

FM-3435 22mm x 50mm

FM-3436 22mm x 100mm

FM-3437 22mm x 140mm

FM-3438 22mm x 200mm

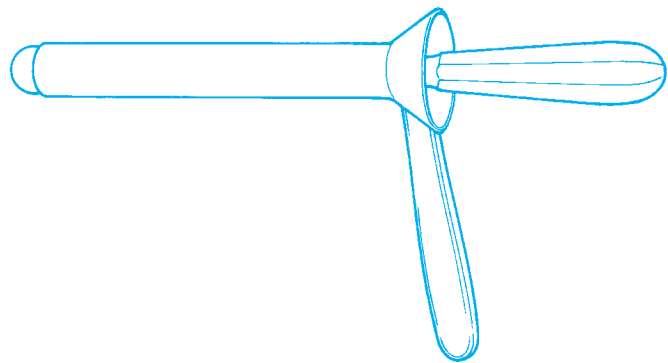

RECTAL SPECULA

Gabriel

with obturator

FM-3439 25mm

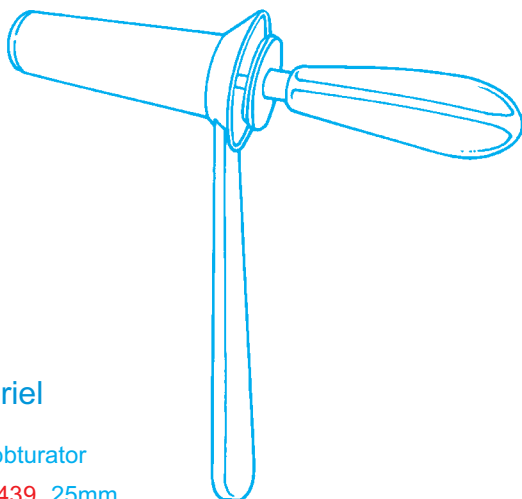

Kelly

with obturator

FM-3440 21mm diameter

FM-3441 27mm diameter

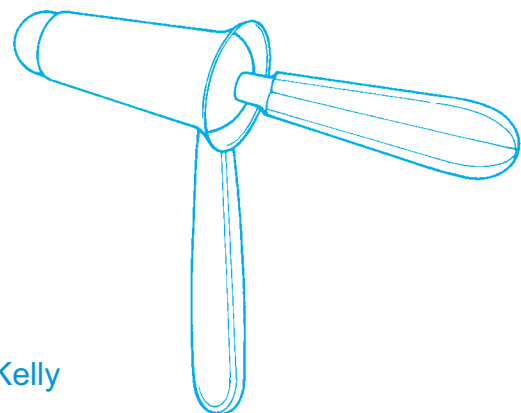

RECTAL SPECULA

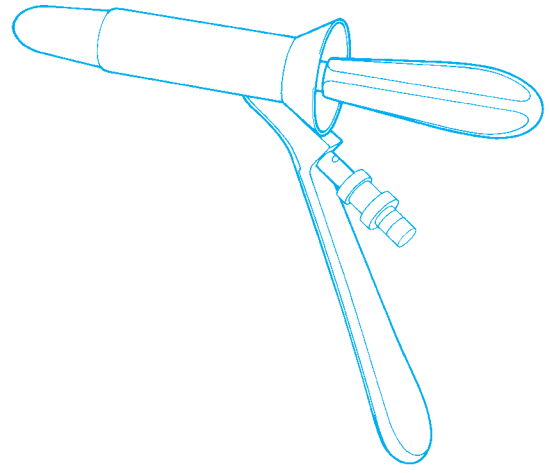

Naunton Morgan

with obturator

FM-3442 17mm diameter

FM-3443 20mm diameter

FM-3444 24mm diameter

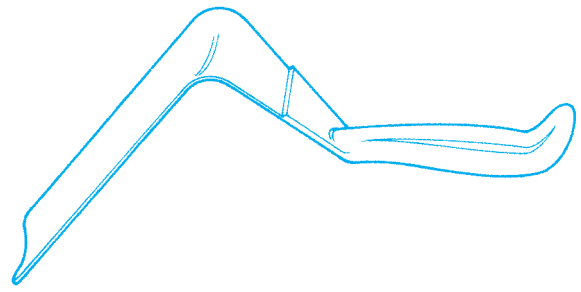

RETRACTORS

Lloyd-Davies

short, without tapered end

FM-3445 125mm x 55mm

long, with tapered end

FM-3446 170mm x 65mm x 50mm

**RETRACTORS
SELF RETAINING**

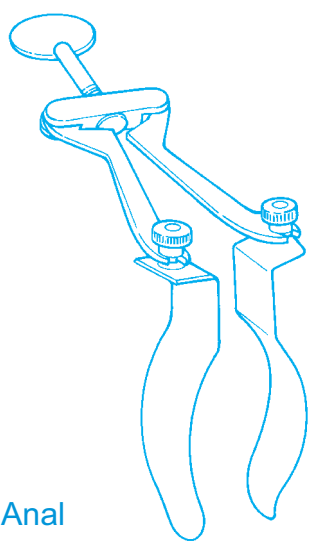

Park Anal

adult

FM-3447 130mm, 95mm blades

child

FM-3448 130mm, 70mm blades

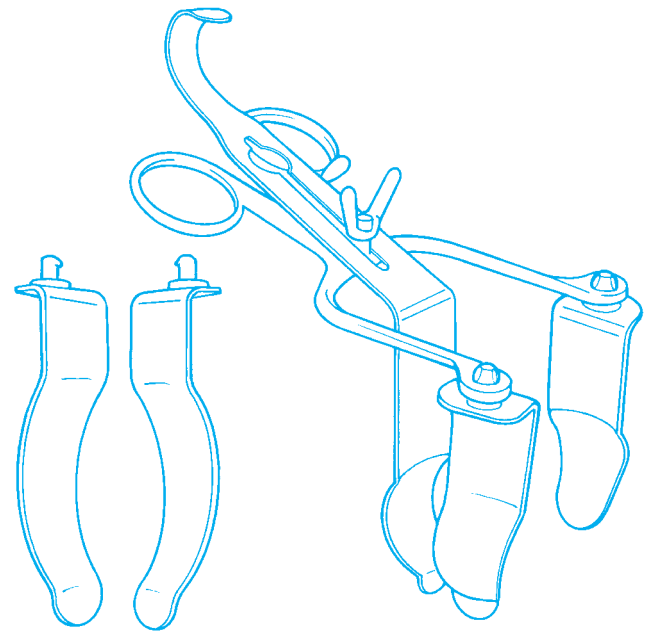

Park Combined

with 2 sets of interchangeable blades and one adjustable centre blade, 140mm

FM-3449 complete

SCISSORS

Abel Abdominal-Perineal

straight

FM-3450 320mm

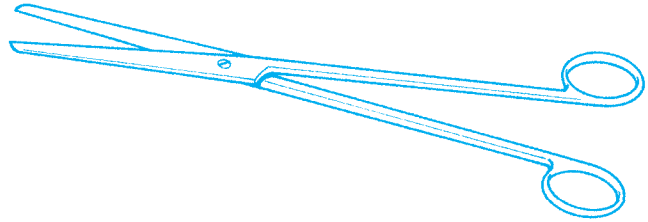

Goligher

straight

FM-3451 300mm

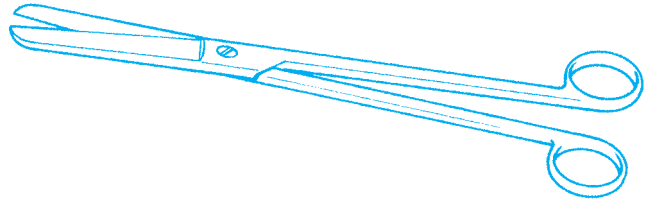

Goligher

curved

FM-3452 300mm

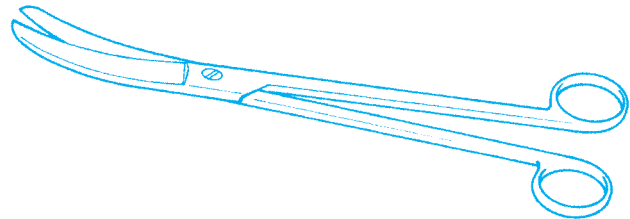

Lloyd-Davies Rectal

straight, flattened blades, blunt points

FM-3453 265mm

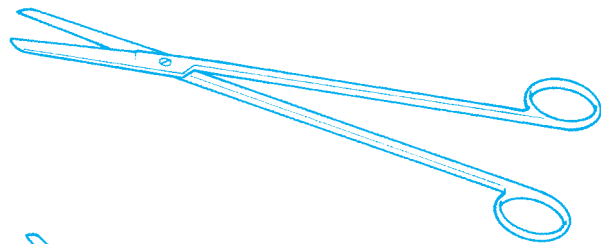

Lloyd-Davies Rectal

curved on flat, flattened blades, blunt points

FM-3454 265mm

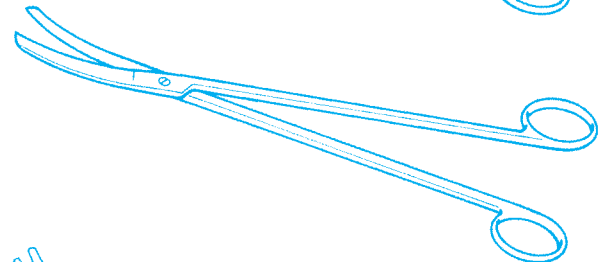

Parks' Lower Colonic

angled on side, blunt/blunt

FM-3455 170mm, blades curved to right

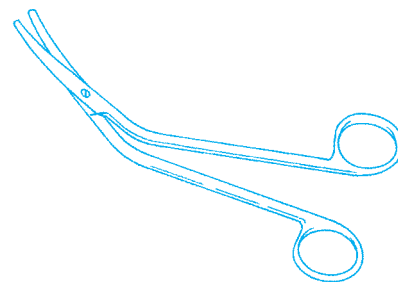

Parks' Lower Colonic

angled on side, blunt/blunt

FM-3456 170mm, blades curved to left

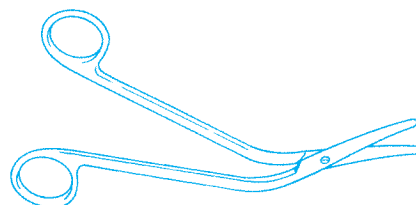

SIGMOIDOSCOPES

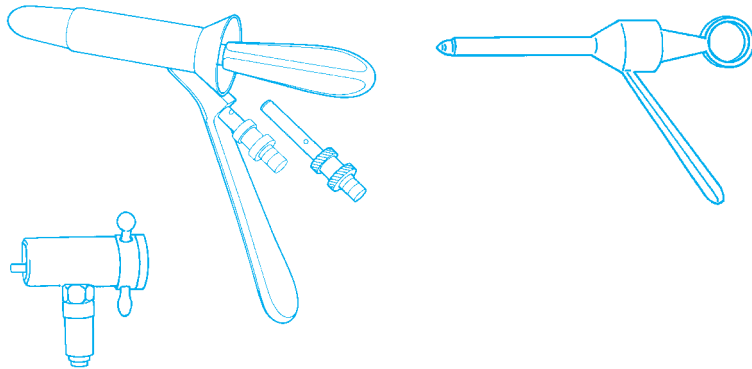

Lloyd-Davies

major set, comprising adult sigmoidoscope with obturator, 300mm x 20mm, adolescent sigmoidoscope with obturator 250mm x 15mm, child proctoscope with obturator 10mm diameter, Naunton Morgan rectal speculum with obturator 20mm diameter with fibre light carriers and fibre optic illumination head unit

FM-3457 complete in case

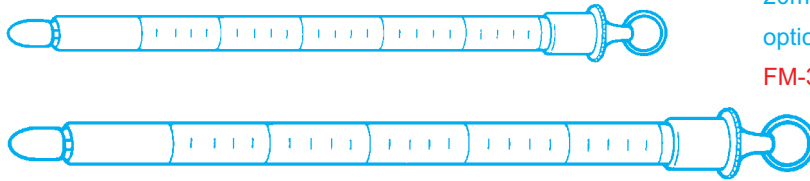

Lloyd-Davies

set comprising 1 graduated tube with obturator, with fibre optic illumination head unit, complete in case

adolescent

FM-3458 tube 250mm x 15mm

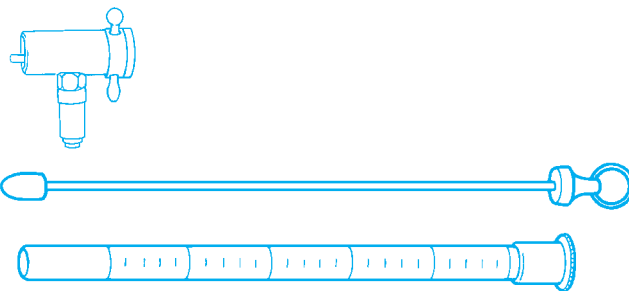

adult

FM-3459 tube 300mm x 20mm

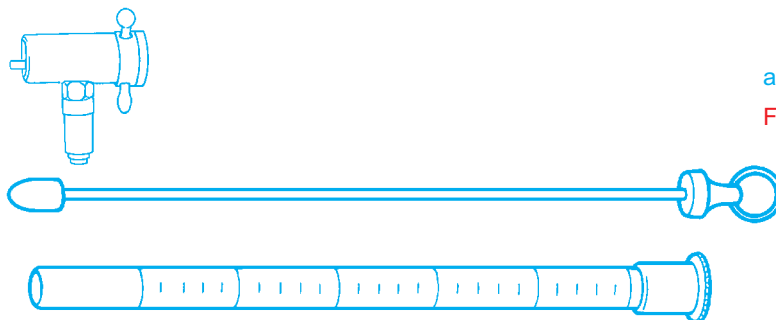

Inflation Bellow

FM-3460 rubber, double

